



TUBERIA



Marca: LESSO
Modelo: TUBERIA
SCH - 80/40

Material: PVC

Conexiones
Disponibles: NPT/
ANSI

Medidas: 1/2" > 8"

x 6 mts





ADAPTADOR

Marca: LESSO

Material: PVC

Estandar: SCH-80

Conexion:
ANSI/NPT

Medidas: 1/2" > 4"



JX Series

• TABLA DE DIMENSIONES

Size(in)	N	L	M	Weight (Lbs)
1/2	3/16	1-23/32	1-3/16	0.0450
3/4	7/32	1-7/8	1-7/16	0.0639
1	7/32	2-1/8	1-3/4	0.1014
1-1/4	7/32	2-1/4	2-1/8	0.1455
1-1/2	1/4	2-5/8	2-3/8	0.2019
2	9/32	2-13/16	2-29/32	0.2959
2-1/2	5/16	3-15/32	3-15/32	0.4993
3	11/32	3-23/32	4-5/32	0.7161
4	3/8	4-7/32	5-1/4	1.1799

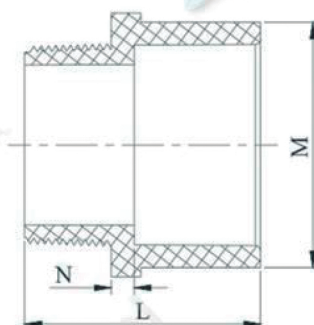



ADAPTADOR CON REDUCCION

Marca:LESSO

Material:PVC

Estandar:SCH-80

Conexion:
ANSI/NPT

Medidas: 3/8" x 1/2"
> 3" x 4"



JX Series

• TABLA DE DIMENSIONES

Size (in)	Std PK	Mstr Ctn
3/8x1/2	50	600
1/2x3/8	50	600
1/2x3/4	50	400
1/2x1	40	240
3/4x1/2	50	600
3/4x1	50	300
1x3/4	50	400
1x1-1/4	50	300
1x1-1/2	50	300
1-1/4x1	25	200
1-1/4x1-1/2	25	150
1-1/2x1-1/4	25	100
1-1/2x2	25	100
2x1-1/2	10	80
2x2-1/2	10	40
2x3	10	60
3x4	5	30

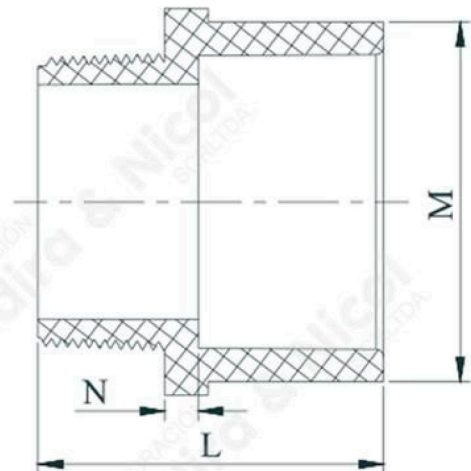



ADAP. CON ROSCA INT/ EXT.

Marca: LESSO

Material: PVC

Estandar: SCH-80

Conexion: ANSI/NPT

Medidas: 1/2" > 3/4"



JX Series

• TABLA DE DIMENSIONES

Size (in)	Std PK	Mstr Ctn
1/2	50	600
3/4	50	400

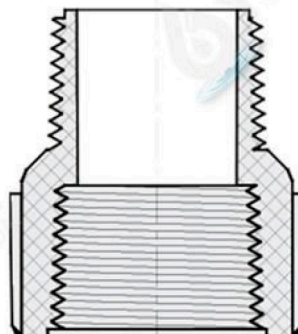



BRIDA GIRATORIA

Marca: LESSO

Material: PVC

Estandar: SCH-80

Conexion: ANSI/NPT

Medidas: 1/2" > 1 1/4"



JX Series

• TABLA DE DIMENSIONES

Size(in)	G	L	Weight (Lbs)
1/2	19/32	1-1/16	0.2359
3/4	21/32	1-3/16	0.3241
1	25/32	1-5/16	0.4652
1-1/4	25/32	1-3/8	0.5071

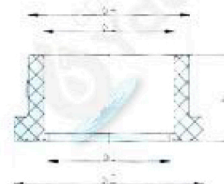
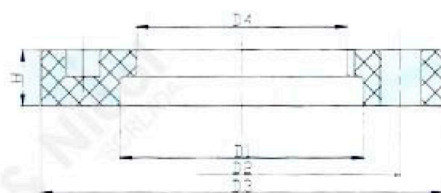



BUGEN A PRESION

Marca: LESSO

Material: PVC

Estandar: SCH-80

Conexion: ANSI

Medidas: 3/8" x 1/4"
> 10" x 8"

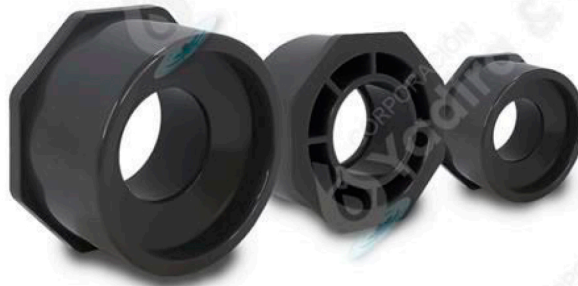

JX Series

• TABLA DE DIMENSIONES

Size(in)	L	N	Weight (Lbs)
3/8x1/4	15/16	5/16	0.0086
1/2x1/4	1-1/16	7/16	0.0214
1/2x3/8	1	1/4	0.0126
3/4x1/2	1-7/32	11/32	0.0220
1x1/2	1-3/8	1/2	0.0639
1x3/4	1-3/8	3/8	0.0485
1-1/4x1/2	1-15/32	19/32	0.1299
1-1/4x3/4	1-15/32	15/32	0.1058
1-1/4x1	1-9/16	13/32	0.0728
1-1/2x1/2	1-11/16	13/16	0.1455
1-1/2x3/4	1-11/16	11/16	0.1861
1-1/2x1	1-11/16	9/16	0.1433
1-1/2x1-1/4	1-5/8	3/8	0.0683
2x1/2	1-13/16	15/16	0.2138
2x3/4	1-13/16	13/16	0.2205
2x1	1-13/16	11/16	0.2209
2x1-1/4	1-13/16	9/16	0.2205
2x1-1/2	1-25/32	13/32	0.1609
2-1/2x1	2-1/32	29/32	0.3538
2-1/2x1-1/4	2-1/32	25/32	0.3417
2-1/2x1-1/2	2-1/32	21/32	0.3942
2-1/2x2	2-1/32	17/32	0.2341
3x1	2-3/16	1-1/16	0.5606
3x1-1/2	2-3/16	13/16	0.5842
3x2	2-3/16	11/16	0.6316
3x2-1/2	2-3/16	7/16	0.3984
4x2	2-19/32	1-3/32	0.9568
4x2-1/2	2-19/32	27/32	1.0044
4x3	2-19/32	23/32	0.9180
6x2	3-15/32	1-31/32	
6x3	3-15/32	1-19/32	2.5001
6x4	3-15/32	1-7/32	2.5342
8x6	4-15/32	1-15/32	
10x6	5-1/2	2-1/2	9.0502
10x8	5-11/32	1-11/32	

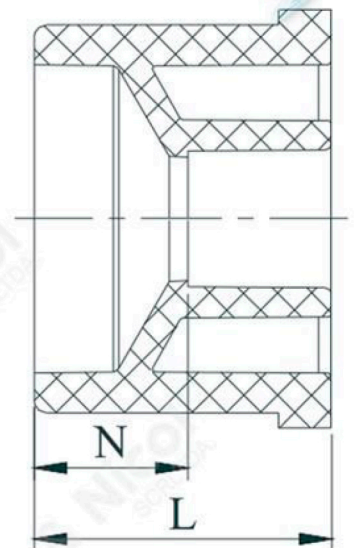



BUGEN MIXTO

Marca: LESSO

Material: PVC

Estandar: SCH-80

Conexion: ANSI/NPT

Medidas: 3/8" x 1/4"
> 6" x 4"



JX Series

• TABLA DE DIMENSIONES

Size(in)	L	N	Weight (Lbs)
3/8x1/4	15/16	11/32	0.0105
1/2x1/4	1-1/16	15/32	0.0229
3/4x1/2	1-7/32	15/32	0.0287
1x1/2	1-3/8	5/8	0.0639
1x3/4	1-3/8	9/16	0.0507
1-1/4x1/2	1-17/32	25/32	0.0886
1-1/4x3/4	1-9/16	3/4	0.1058
1-1/4x1	1-9/16	9/16	0.0860
1-1/2x1/2	1-21/32	29/32	0.1521
1-1/2x3/4	1-21/32	27/32	0.1356
1-1/2x1	1-21/32	21/32	0.1433
1-1/2x1-1/4	1-21/32	5/8	0.0959
2x1/2	1-25/32	1-1/32	0.2183
2x3/4	1-25/32	31/32	0.2183
2x1	1-25/32	25/32	0.2229
2x1-1/4	1-23/32	11/16	0.2313
2x1-1/2	1-25/32	3/4	0.1808
2-1/2x2	2-1/32	31/32	0.2798
3x2	2-3/16	1-1/8	0.4802
3x2-1/2	2-3/16	3/4	0.4588
4x2	2-19/32	1-17/32	0.9901
4x3	2-9/16	1	0.9839
6x4	3-13/32	1-3/4	2.4972

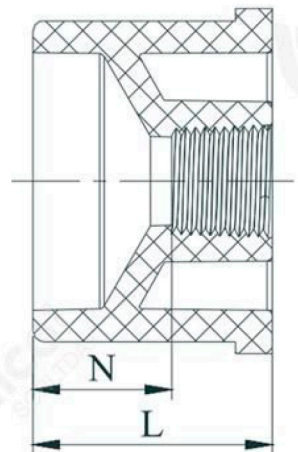



CODO 45° CON ROSCA

Marca: LESSO

Material: PVC

Estandar: SCH-80

Conexion: NPT

Medidas: 1/2" > 4"



JX Series

• TABLA DE DIMENSIONES

Size(in)	J	H	M	Weight (Lbs)
1/2	1/4	1	1-9/32	0.0794
3/4	9/32	1-3/32	1-1/2	0.1102
1	11/32	1-11/32	1-13/16	0.1896
1-1/4	3/8	1-13/32	2-7/32	0.2637
1-1/2	9/16	1-9/16	2-1/2	0.3578
2	21/32	1-23/32	3	0.4996
2-1/2	29/32	2-3/8	3-19/32	0.9872
3	15/16	2-17/32	4-5/16	1.4143
4	1-3/16	2-27/32	5-7/16	2.2889

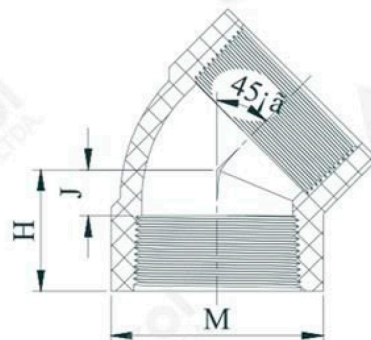



CODO 45° A PRESION

Marca: LESSO

Material: PVC

Estandar: SCH-80

Conexion: ANSI

Medidas: 1/4" > 6"



JX Series

• TABLA DE DIMENSIONES

Part Number	Size(in)	J	H	M	Weight (Lbs)
817-002	1/4	5/32	25/32	27/32	0.0265
817-003	3/8	3/16	15/16	1	0.0399
817-005	1/2	1/4	1-1/8	1-3/16	0.0683
817-007	3/4	5/16	1-5/16	1-7/16	0.1036
817-010	1	3/8	1-1/2	1-3/4	0.1742
817-012	1-1/4	7/16	1-11/16	2-3/32	0.2293
817-015	1-1/2	15/32	1-27/32	2-11/32	0.3042
817-020	2	5/8	2-1/8	2-7/8	0.4740
817-025	2-1/2	11/16	2-7/16	3-15/32	0.7895
817-030	3	25/32	2-21/32	4-5/32	1.1213
817-040	4	1-1/16	3-5/16	5-1/4	1.9992
817-060	6	1-3/4	4-3/4	7-19/32	5.4701

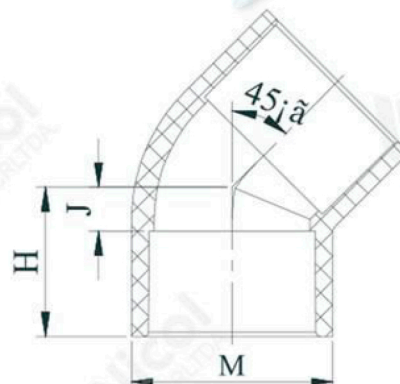



CODO 90° CON ROSCA

Marca: LESSO

Material: PVC

Estandar: SCH-80

Conexion: NPT

Medidas: 1/4" > 4"



JX Series

• TABLA DE DIMENSIONES

Size(in)	G	H	M	Weight (Lbs)
1/4	11/32	15/16	27/32	0.0346
3/8	7/16	1-1/32	1	0.0487
1/2	1/2	1-1/4	1-9/32	0.0948
3/4	5/8	1-13/32	1-1/2	0.1279
1	3/4	1-23/32	1-13/16	0.2205
1-1/4	15/16	1-31/32	2-7/32	0.3329
1-1/2	1-3/32	2-1/8	2-1/2	0.4605
2	1-11/32	2-13/32	3	0.6687
2-1/2	1-11/16	3-5/32	3-19/32	1.2293
3	2-1/16	3-5/8	4-5/16	1.8761
4	2-19/32	4-1/4	5-7/16	3.1513

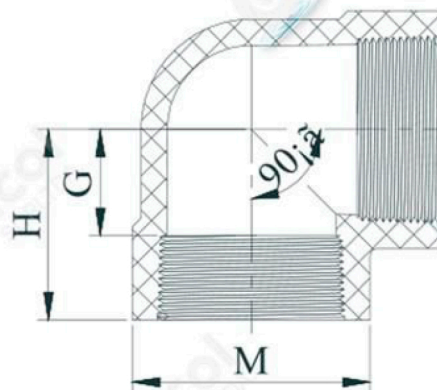



CODO 90° MIXTO

Marca: LESSO

Material: PVC

Estandar: SCH-80

Conexion: ANSI/NPT

Medidas: 1/2" > 2"



JX Series

• TABLA DE DIMENSIONES

Size(in)	G	G1	H	H1	M	M1	Weight (Lbs)
1/2	1/2	19/32	1-3/8	1-5/16	1-3/16	1-9/32	0.0926
3/4	21/32	21/32	1-21/32	1-15/32	1-7/16	1-1/2	0.1389
1	11/16	7/8	1-13/16	1-27/32	1-3/4	1-13/16	0.2359
1-1/4	15/16	1	2-3/16	2-1/32	2-1/8	2-7/32	0.3605
1-1/2	1-1/32	1-5/32	2-13/32	2-5/32	2-3/8	2-1/2	0.4694
2	1-9/32	1-11/32	2-25/32	2-13/32	2-29/32	3	0.6680

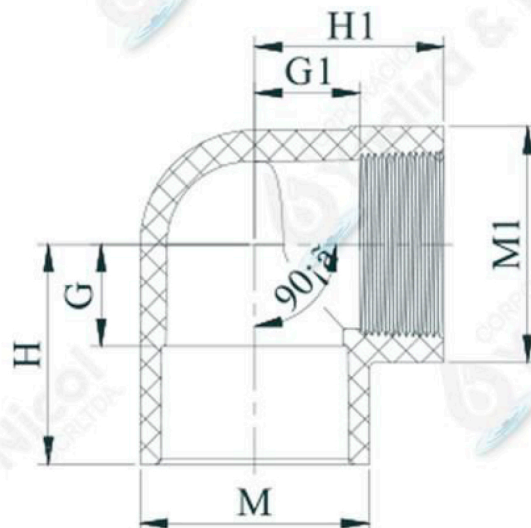



CODO 90° A PRESION

Marca: LESSO

Material: PVC

Estandar: SCH-80

Conexion: ANSI

Medidas: 1/4" > 8"



JX Series

• TABLA DE DIMENSIONES

Size(in)	G	H	M	Weight (Lbs)
1/4	3/8	1	13/16	0.0311
3/8	13/32	1-5/32	1	0.0487
1/2	9/16	1-7/16	1-3/16	0.0926
3/4	21/32	1-21/32	1-7/16	0.1279
1	13/16	1-15/16	1-3/4	0.2050
1-1/4	31/32	2-1/4	2-1/8	0.3307
1-1/2	1-3/32	2-15/32	2-3/8	0.3858
2	1-11/32	2-27/32	2-7/8	0.5975
2-1/2	1-21/32	3-13/32	3-15/32	1.0604
3	1-31/32	3-27/32	4-5/32	1.5234
4	2-1/2	4-3/4	5-1/4	2.7351
6	3-21/32	6-21/32	7-19/32	7.1961
8	4-11/16	8-11/16	9-23/32	14.0060

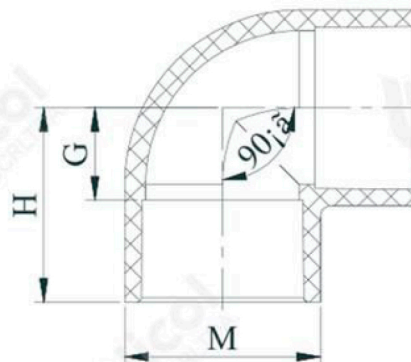



CRUZ O CRUCETA

Marca: LESSO

Material: PVC

Estandar: SCH-80

Conexion: ANSI

Medidas: 1/2" >4"



JX Series

• TABLA DE DIMENSIONES

Size(in)	G	G1	H	H1	L	L1	M
3	1-31/32	1-31/32	3-27/32	3-27/32	7-23/32	7-23/32	4-5/32
4	2-5/8	2-5/8	4-7/8	4-7/8	9-23/32	9-23/32	5-1/4

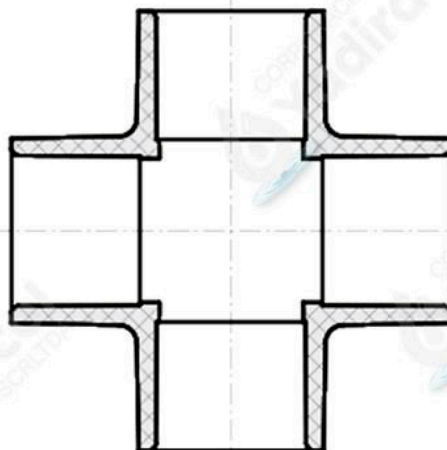



NIPLE CON ROSCA

Marca: LESSO

Material: PVC

Estandar: SCH-80

Conexion: NPT

Medidas: 1/8" > 2"



JX Series

• TABLA DE DIMENSIONES

N	L	Weight (Lbs)
1/8	1-13/32	0.0251

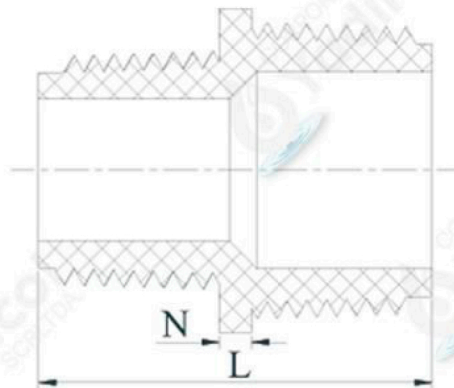



REDUCCION BUSHING

Marca: LESSO

Material: PVC

Estandar: SCH-80

Conexion: NPT

Medidas: 1/2" x 1/4" >
4 x 3"



JX Series

• TABLA DE DIMENSIONES

Size(in)	L	N	Weight (Lbs)
1/2x1/4	29/32	5/16	0.0154
1/2x3/8	29/32	5/16	0.0132
3/4x1/4	29/32	5/16	0.0287
3/4x3/8	29/32	5/16	0.0243
3/4x1/2	29/32	5/32	0.0220
1x3/8	1-1/32	7/16	0.0540
1x1/2	1-1/16	5/16	0.0441
1x3/4	1-1/16	1/4	0.0331
1-1/4x1/2	1-1/16	5/16	0.0816
1-1/4x3/4	1-1/16	1/4	0.0661
1-1/4x1	1-1/16	3/32	0.0529
1-1/2x3/4	1-3/16	3/8	0.0933
1-1/2x1	1-3/16	3/16	0.0891
1-1/2x1-1/4	1-7/32	3/16	0.0558
2x1/2	1-5/16	9/16	0.1671
2-1/2x2	1-11/16	5/8	0.1995

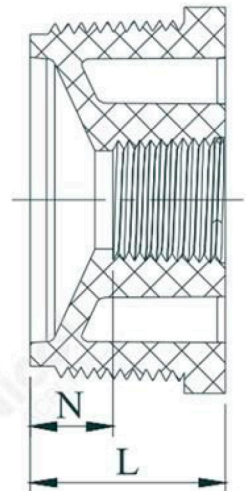



REDUCCION CAMPANA

Marca: LESSO

Material: PVC

Estandar: SCH-80

Conexion: ANSI

Medidas: 3/4" x 1/2"
> 8" x 6"



JX Series

• TABLA DE DIMENSIONES

Size(in)	N	L	M	M1	Weight (Lbs)
3/4x1/2	1/8	2	1-7/16	1-3/16	0.0705
1x1/2	7/32	2-7/32	1-3/4	1-3/16	0.1058
1x3/4	1/8	2-1/4	1-3/4	1-7/16	0.1102
1-1/4x1/2	15/32	2-19/32	2-1/8	1-3/16	0.1543
1-1/4x3/4	3/8	2-5/8	2-1/8	1-7/16	0.1609
1-1/4x1	3/16	2-9/16	2-1/8	1-3/4	0.1698
1-1/2x3/4	1/2	2-7/8	2-3/8	1-7/16	0.2121
1-1/2x1	3/8	2-7/8	2-3/8	1-3/4	0.2205
1-1/2x1-1/4	3/16	2-13/16	2-3/8	2-1/8	0.2324
2x1-1/2	11/32	3-7/32	2-29/32	2-3/8	0.3441
3x2	21/32	4-1/32	4-5/32	2-29/32	0.7372
4x3	21/32	4-13/16	5-1/4	4-5/32	1.3012
6x4	1-3/8	6-5/8	7-19/32	5-1/4	3.2441
8x6	1-9/16	8-7/32	9-23/32	7-19/32	

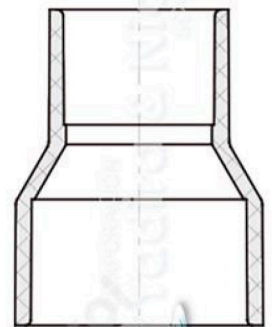



REDUCCION CAMPANA

Marca: LESSO

Material: PVC

Estandar: SCH-40

Conexion: ANSI

Medidas: 3/4" x 1/2"
> 8" x 6"



JX Series

• TABLA DE DIMENSIONES

Size(in)	N	L	M	M1	Weight (Lbs)
3/4x1/2	1/8	2	1-7/16	1-3/16	0.0705
1x1/2	7/32	2-7/32	1-3/4	1-3/16	0.1058
1x3/4	1/8	2-1/4	1-3/4	1-7/16	0.1102
1-1/4x1/2	15/32	2-19/32	2-1/8	1-3/16	0.1543
1-1/4x3/4	3/8	2-5/8	2-1/8	1-7/16	0.1609
1-1/4x1	3/16	2-9/16	2-1/8	1-3/4	0.1698
1-1/2x3/4	1/2	2-7/8	2-3/8	1-7/16	0.2121
1-1/2x1	3/8	2-7/8	2-3/8	1-3/4	0.2205
1-1/2x1-1/4	3/16	2-13/16	2-3/8	2-1/8	0.2324
2x1-1/2	11/32	3-7/32	2-29/32	2-3/8	0.3441
3x2	21/32	4-1/32	4-5/32	2-29/32	0.7372
4x3	21/32	4-13/16	5-1/4	4-5/32	1.3012
6x4	1-3/8	6-5/8	7-19/32	5-1/4	3.2441
8x6	1-9/16	8-7/32	9-23/32	7-19/32	

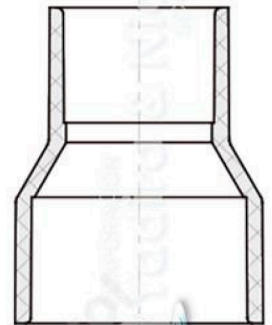



TAPON HEMBRA

Marca: LESSO
Modelo: TAPON
HEMRBA SCH-80

Material: PVC

Conexiones
Disponibles: ANSI

Medidas: 3/8" > 12"



JX Series

• TABLA DE DIMENSIONES

Size (in)	Std PK	Mstr Ctn
3/8	100	1200
1/2	100	1200
3/4	50	600
1	50	300
1-1/4	25	150
1-1/2	25	150
2	10	80
2-1/2	10	60
3	10	40
4	6	24
5	6	24
6	8	0
8	12	0
10	12	0
12	6	0

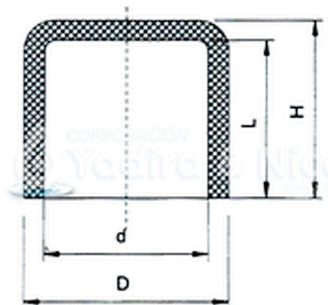



TAPON CON ROSCA HEMBRA

Marca: L ESSO

Material: PVC

Estandar: SCH-80

Conexion: NPT

Medidas: 1/4" > 4



JX Series

• TABLA DE DIMENSIONES

Size(in)	W	M	Weight (Lbs)
1/4	27/32	31/32	0.0174
3/8	7/8	1-1/8	0.0227
1/2	1-3/32	1-13/32	0.0463
3/4	1-7/32	1-5/8	0.0617
1	1-15/32	1-15/16	0.1080
1-1/4	1-9/16	2-12/32	0.1653
1-1/2	1-9/16	2-21/32	0.2070
2	1-25/32	3-3/16	0.2921
2-1/2	2-1/4	3-13/16	0.5304
3	2-3/8	4-5/8	0.7802
4	2-27/32	5-3/4	1.3808

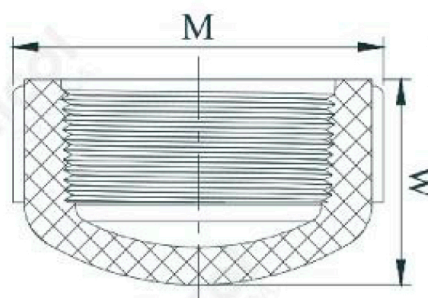



TAPON CON ROSCA MACHO

Marca: LESSO

Material: PVC

Estandar: SCH-80

Conexion: NPT

Medidas: 1/4" > 4"



JX Series

• TABLA DE DIMENSIONES

Size(in)	L	Weight (Lbs)
1/4	21/32	0.0064
3/8	25/32	0.0108
1/2	7/8	0.0154
3/4	7/8	0.0265
1	1-1/32	0.0463
1-1/4	1-3/32	0.0683
1-1/2	1-5/16	0.1023
2	1-11/32	0.1534
2-1/2	1-13/16	0.2857
3	1-29/32	0.4209
4	2	0.6753

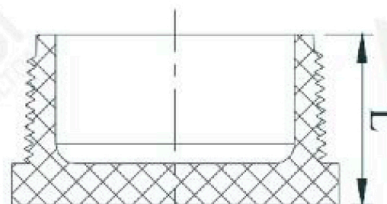



TEE A PRESION

Marca: LESSO

Material: PVC

Estandar: SCH-80

Conexion: ANSI

Medidas: 1/4" > 8



JX Series

• TABLA DE DIMENSIONES

Size(in)	G	G1	H	H1	L	M	Weight (Lbs)
1/4	3/8	3/8	1	1	2	13/16	0.0419
1/2	9/16	9/16	1-7/16	1-7/16	2-7/8	1-1/4	0.1279
3/4	21/32	21/32	1-21/32	1-21/32	3-5/16	1-15/32	0.1808
1	3/16	13/16	1-15/16	1-15/16	3-27/32	1-25/32	0.2976
1-1/4	31/32	31/32	2-1/4	2-1/4	4-15/32	2-5/32	0.4409
1-1/2	1-3/32	1-3/32	2-15/32	2-15/32	4-31/32	2-3/8	0.5335
2	1-11/32	1-11/32	2-27/32	2-27/32	5-23/32	2-7/8	0.8047
2-1/2	1-21/32	1-21/32	3-13/32	3-13/32	6-13/16	3-15/32	1.3741
3	1-31/32	1-31/32	3-27/32	3-27/32	7-23/32	4-5/32	2.0128
4	2-1/2	2-1/2	4-3/4	4-3/4	9-17/32	5-1/4	3.5078
6	3-21/32	3-21/32	6-21/32	6-21/32	13-5/16	7-19/32	9.4114
8	4-11/16	4-11/16	8-11/16	8-11/16	17-13/32	9-23/32	19.1916

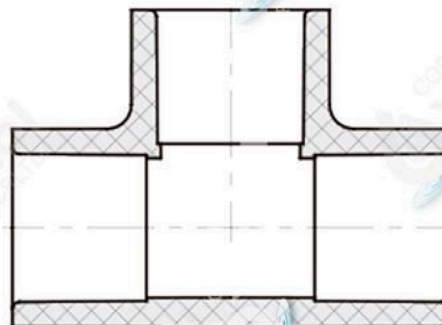



TEE MIXTA

Marca: LESSO

Material: PVC

Estandar: SCH-80

Conexion: ANSI/ NPT

Medidas: 1/2" > 2



JX Series

• TABLA DE DIMENSIONES

Size(in)	G	G1	H	H1	L	M	M1	Weight (Lbs)
1/2	17/32	9/16	1-13/32	1-5/16	2-27/32	1-9/32	1-9/32	0.1411
3/4	5/8	21/32	1-5/8	1-15/32	3-9/32	1-1/2	1-1/2	0.1940
1	25/32	13/16	1-29/32	1-13/16	3-13/16	1-3/4	1-13/16	0.2901
1-1/2	31/32	1-1/4	2-3/8	2-9/32	4-23/32	2-3/8	2-1/2	0.5545
2	1-11/32	1-3/8	2-27/32	2-7/16	5-21/32	2-29/32	3	0.8519

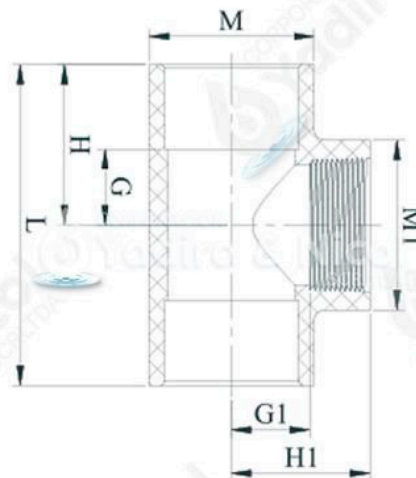



TEE A PRESION MILIMETRADA

Marca: LESSO

Material: PVC

Estandar: SCH-80

Conexion: ANSI



JX Series

• TABLA DE DIMENSIONES

Size(in)	G	G1	G2	H	H1	H2	L	M	M1	Weight (Lbs)
3/4×3/4×1/2	9/16	11/16	9/16	1-9/16	1-9/16	1-9/16	3-1/8	1-15/32	1-1/4	0.1631
1×1×1/2	9/16	13/16	9/16	1-11/16	1-23/32	1-11/16	3-11/32	1-3/4	1-3/16	0.2138
1×1×3/4	21/32	13/16	21/32	1-25/32	1-13/16	1-25/32	3-19/32	1-3/4	1-7/16	0.2385
1-1/4×1-1/4×1	25/32	31/32	25/32	2-1/32	2-3/32	2-1/32	4-3/32	2-1/8	1-3/4	0.3556
1-1/2×1-1/2×3/4	21/32	1-1/32	21/32	2-1/16	2-1/32	2-1/16	4-3/32	2-3/8	1-7/16	0.3940
1-1/2×1-1/2×1	25/32	1-5/32	25/32	2-5/32	2-9/32	2-5/32	4-11/32	2-3/8	1-3/4	0.4436
2×2×1/2	19/32	1-3/8	19/32	2-3/32	2-1/4	2-3/32	4-7/32	2-29/32	1-3/16	0.5357
2×2×3/4	11/16	1-3/8	11/16	2-3/16	2-3/8	2-3/16	4-3/8	2-29/32	1-7/16	0.5668
2×2×1	7/8	1-13/32	7/8	2-3/8	2-17/32	2-3/8	4-23/32	2-29/32	1-3/4	0.6323
2×2×1-1/4	31/32	1-11/32	31/32	2-15/32	2-19/32	2-15/32	4-31/32	2-29/32	2-1/8	0.6731
2×2×1-1/2	1-5/32	1-11/32	1-5/32	2-21/32	2-3/4	2-21/32	5-5/16	2-29/32	2-3/8	0.7646
2-1/2×2-1/2×1-1/4	1-1/32	1-21/32	1-1/32	2-25/32	2-29/32	2-25/32	5-9/16	3-15/32	2-1/8	0.9811
2-1/2×2-1/2×1-1/2	1-7/32	1-25/32	1-7/32	2-31/32	3-5/32	2-31/32	5-15/16	3-15/32	2-3/8	1.0895
2-1/2×2-1/2×2	1-7/16	1-3/4	1-7/16	3-3/16	3-1/4	3-3/16	6-3/8	3-15/32	2-29/32	1.2150
3×3×1-1/2	1-5/32	2-1/16	1-5/32	3-1/32	3-7/16	3-1/32	6-1/16	4-5/32	2-3/8	1.4021
3×3×2	1-15/32	1-31/32	1-15/32	3-11/32	3-15/32	3-11/32	6-11/16	4-5/32	2-29/32	1.5741
4×4×2	1-13/32	2-17/32	1-13/32	3-21/32	4-1/32	3-21/32	7-11/32	5-1/4	2-29/32	2.3693
4×4×3	2-5/32	2-23/32	2-5/32	4-13/32	4-19/32	4-13/32	8-13/16	5-1/4	4-5/32	3.0748
6×6×3	2-1/16	3-5/8	2-1/16	5-1/16	5-1/2	5-1/16	10-1/8	7-19/32	4-5/16	6.4296
6×6×4	2-5/8	3-19/32	2-5/8	5-5/8	5-27/32	5-5/8	11-7/32	7-19/32	5-1/4	
8×8×6	3-7/8	4-27/32	3-7/8	7-7/8	7-27/32	7-7/8	15-3/4	9-23/32	7-19/32	

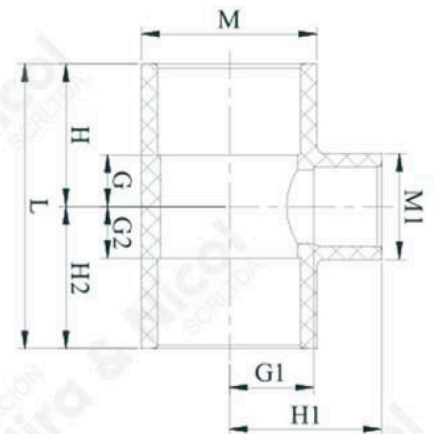



TEE CON REDUCCION

Marca: LESSO

Material: PVC

Estandar: SCH-80

Conexion: ANSI

Medidas: 3/4" x 3/4"
x 1/2" >
8" x 8" x 6"



JX Series

• TABLA DE DIMENSIONES

Size(in)	G	G1	G2	H	H1	H2	L	M	M1	Weight (Lbs)
3/4x3/4x1/2	9/16	11/16	9/16	1-9/16	1-9/16	1-9/16	3-1/8	1-15/32	1-1/4	0.1631
1x1x1/2	9/16	13/16	9/16	1-11/16	1-23/32	1-11/16	3-11/32	1-3/4	1-3/16	0.2138
1x1x3/4	21/32	13/16	21/32	1-25/32	1-13/16	1-25/32	3-19/32	1-3/4	1-7/16	0.2385
1-1/4x1-1/4x1	25/32	31/32	25/32	2-1/32	2-3/32	2-1/32	4-3/32	2-1/8	1-3/4	0.3556
1-1/2x1-1/2x3/4	21/32	1-1/32	21/32	2-1/16	2-1/32	2-1/16	4-3/32	2-3/8	1-7/16	0.3940
1-1/2x1-1/2x1	25/32	1-5/32	25/32	2-5/32	2-9/32	2-5/32	4-11/32	2-3/8	1-3/4	0.4436
2x2x1/2	19/32	1-3/8	19/32	2-3/32	2-1/4	2-3/32	4-7/32	2-29/32	1-3/16	0.5357
2x2x3/4	11/16	1-3/8	11/16	2-3/16	2-3/8	2-3/16	4-3/8	2-29/32	1-7/16	0.5668
2x2x1	7/8	1-13/32	7/8	2-3/8	2-17/32	2-3/8	4-23/32	2-29/32	1-3/4	0.6323
2x2x1-1/4	31/32	1-11/32	31/32	2-15/32	2-19/32	2-15/32	4-31/32	2-29/32	2-1/8	0.6731
2x2x1-1/2	1-5/32	1-11/32	1-5/32	2-21/32	2-3/4	2-21/32	5-5/16	2-29/32	2-3/8	0.7646
2-1/2x2-1/2x1-1/4	1-1/32	1-21/32	1-1/32	2-25/32	2-29/32	2-25/32	5-9/16	3-15/32	2-1/8	0.9811
2-1/2x2-1/2x1-1/2	1-7/32	1-25/32	1-7/32	2-31/32	3-5/32	2-31/32	5-15/16	3-15/32	2-3/8	1.0895
2-1/2x2-1/2x2	1-7/16	1-3/4	1-7/16	3-3/16	3-1/4	3-3/16	6-3/8	3-15/32	2-29/32	1.2150
3x3x1-1/2	1-5/32	2-1/16	1-5/32	3-1/32	3-7/16	3-1/32	6-1/16	4-5/32	2-3/8	1.4021
3x3x2	1-15/32	1-31/32	1-15/32	3-11/32	3-15/32	3-11/32	6-11/16	4-5/32	2-29/32	1.5741
4x4x2	1-13/32	2-17/32	1-13/32	3-21/32	4-1/32	3-21/32	7-11/32	5-1/4	2-29/32	2.3693
4x4x3	2-5/32	2-23/32	2-5/32	4-13/32	4-19/32	4-13/32	8-13/16	5-1/4	4-5/32	3.0748
6x6x3	2-1/16	3-5/8	2-1/16	5-1/16	5-1/2	5-1/16	10-1/8	7-19/32	4-5/16	6.4296
6x6x4	2-5/8	3-19/32	2-5/8	5-5/8	5-27/32	5-5/8	11-7/32	7-19/32	5-1/4	
8x8x6	3-7/8	4-27/32	3-7/8	7-7/8	7-27/32	7-7/8	15-3/4	9-23/32	7-19/32	

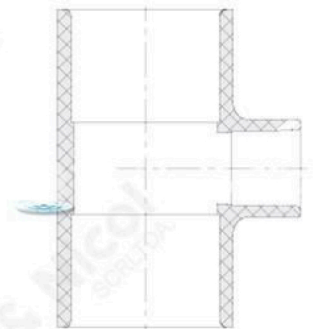



TEE CON ROSCA

Marca: LESSO

Material: PVC

Estandar: SCH-80

Conexion: NPT

Medidas: 1/4" > 4"



JX Series

• TABLA DE DIMENSIONES

Size(in)	G	H	L	M	Weight (Lbs)
1/4	13/32	31/32	1-31/32	27/32	0.0498
3/8	15/32	1-1/16	2-1/8	1	0.0670
1/2	1/2	1-1/4	2-1/2	1-9/32	0.1235
3/4	5/8	1-13/32	2-27/32	1-1/2	0.1764
1	3/4	1-3/4	3-15/32	1-13/16	0.2976
1-1/4	15/16	1-31/32	3-29/32	2-7/32	0.4489
1-1/2	1-3/32	2-1/8	4-1/4	2-1/2	0.5891
2	1-11/32	2-13/32	4-13/16	3	0.8314
2-1/2	1-11/16	3-5/32	6-5/16	3-19/32	1.5686
3	2-1/16	3-5/8	7-1/4	4-5/16	2.3713
4	2-19/32	4-1/4	8-1/2	5-7/16	

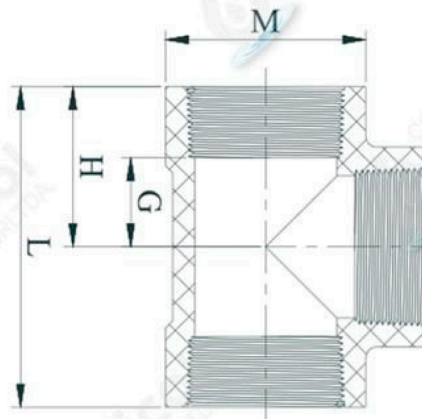



TEE A PRESION

Marca: LESSO

Material: PVC

Estandar: SCH-80

Conexion: ANSI

Medidas: 1/4" > 8"



JX Series

• TABLA DE DIMENSIONES

Size(in)	G	G1	H	H1	L	M	Weight (Lbs)
1/4	3/8	3/8	1	1	2	13/16	0.0419
1/2	9/16	9/16	1-7/16	1-7/16	2-7/8	1-1/4	0.1279
3/4	21/32	21/32	1-21/32	1-21/32	3-5/16	1-15/32	0.1808
1	3/16	13/16	1-15/16	1-15/16	3-27/32	1-25/32	0.2976
1-1/4	31/32	31/32	2-1/4	2-1/4	4-15/32	2-5/32	0.4409
1-1/2	1-3/32	1-3/32	2-15/32	2-15/32	4-31/32	2-3/8	0.5335
2	1-11/32	1-11/32	2-27/32	2-27/32	5-23/32	2-7/8	0.8047
2-1/2	1-21/32	1-21/32	3-13/32	3-13/32	6-13/16	3-15/32	1.3741
3	1-31/32	1-31/32	3-27/32	3-27/32	7-23/32	4-5/32	2.0128
4	2-1/2	2-1/2	4-3/4	4-3/4	9-17/32	5-1/4	3.5078
6	3-21/32	3-21/32	6-21/32	6-21/32	13-5/16	7-19/32	9.4114
8	4-11/16	4-11/16	8-11/16	8-11/16	17-13/32	9-23/32	19.1916





TRICODO

Marca: LESSO

Material: PVC

Estandar: SCH-80

Conexion: NPT

Medidas: 1/4" > 2"



JX Series

• TABLA DE DIMENSIONES

Size (in)	Std PK	Mstr Ctn
1/2	50	300
3/4	50	300
1	25	150
1-1/2	10	60
2	10	40

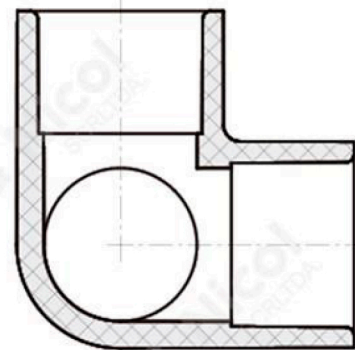



UNION CON ROSCA

Marca: LESSO

Material: PVC

Estandar: SCH-80

Conexion: NPT

Medidas: 1/4" > 4



JX Series

• TABLA DE DIMENSIONES

Size(in)	N	L	M	Weight (Lbs)
1/4	3/32	1-1/4	27/32	0.0249
1/2	3/32	1-19/32	1-9/32	0.0661
3/4	3/32	1-23/32	1-1/2	0.0860
1	1/8	2-3/32	1-13/16	0.1565
1-1/4	5/32	2-7/32	2-7/32	0.2116
1-1/2	3/16	2-1/4	2-1/2	0.2690
2	3/16	2-5/16	3	0.3704
2-1/2	3/16	3-1/8	3-19/32	0.6947
3	3/16	3-11/32	4-5/16	1.0097
4	3/16	3-1/2	5-7/16	1.5397

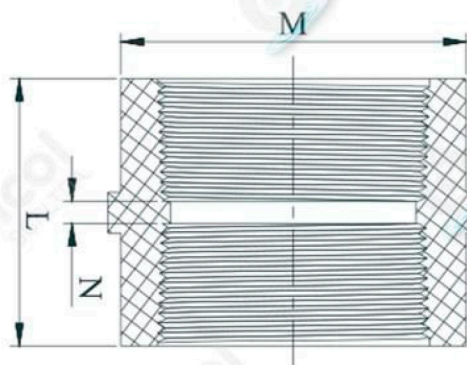



UNION MIXTA

Marca: LESSO

Material: PVC

Estandar: SCH-80

Conexion: NPT/ANSI

Medidas: 1/4" > 4



JX Series

• TABLA DE DIMENSIONES

Size(in)	N	L	M	M1	Weight (Lbs)
1/4	3/32	1-9/32	27/32	27/32	0.0240
1/2	1/8	1-3/4	1-3/16	1-9/32	0.0661
3/4	1/8	1-15/16	1-7/16	1-1/2	0.0882
1	1/8	2-1/4	1-3/4	1-13/16	0.1433
1-1/4	1/8	2-13/32	2-1/8	2-7/32	0.2050
1-1/2	1/8	2-17/32	2-3/8	2-1/2	0.2734
2	1/8	2-11/16	2-29/32	3	0.3594
2-1/2	5/32	3-3/8	3-15/32	3-19/32	0.6396
3	3/16	3-21/32	4-5/32	4-5/16	0.9301
4	3/16	4-3/32	5-1/4	5-7/16	1.4712

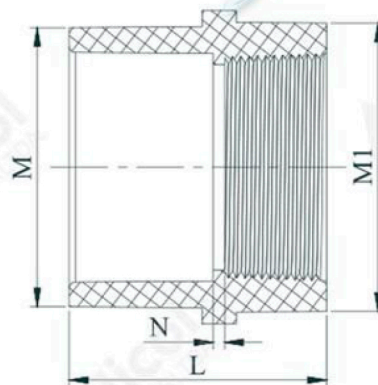



UNION SIMPLE

Marca: LESSO

Material: PVC

Estandar: SCH-80

Conexion: ANSI

Medidas: 1/4" > 12



JX Series

• TABLA DE DIMENSIONES

Size(in)	N	L	M	Weight (Lbs)
1/4	3/32	1-11/32	27/32	0.0225
1/2	1/8	1-7/8	1-3/16	0.0573
3/4	1/8	2-1/8	1-7/16	0.0816
1	1/8	2-3/8	1-3/4	0.1279
1-1/4	1/8	2-5/8	2-1/8	0.1852
1-1/2	1/8	2-7/8	2-11/32	0.2161
2	1/8	3-1/8	2-27/32	0.3175
2-1/2	7/32	3-23/32	3-15/32	0.5867
3	7/32	3-31/32	4-5/32	0.8047
4	7/32	4-23/32	5-1/4	1.3719
6	5/16	6-5/16	7-19/32	3.3817
8	9/32	8-9/32	9-23/32	6.7671
10	9/32	10-9/32	12-1/16	
12	13/32	12-13/32	14-1/4	

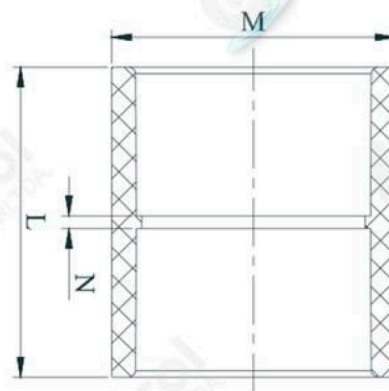



UNION UNIVERSAL SIMPLE PRESION

Marca: LESSO

Material: PVC

Estandar: SCH-80

Conexion: ANSI

Medidas: 3/8" > 4"



JX Series

• TABLA DE DIMENSIONES

Size(in)	N	L	M	NUT O.D.	Weight (Lbs)
3/8	9/32	1-17/32	7/8	1-9/16	0.0697
1/2	5/16	2-1/16	1-1/4	1-15/16	0.1358
3/4	13/32	2-13/32	1-15/32	2-3/16	0.1812
1	7/16	2-11/16	1-13/16	2-19/32	0.2703
1-1/4	15/32	2-31/32	2-3/16	3	0.3911
1-1/2	5/8	3-3/8	2-7/16	3-7/16	0.5461
2	11/16	3-11/16	2-31/32	4-1/16	0.7994
3	23/32	4-15/32	4-1/4	5-1/2	1.7342

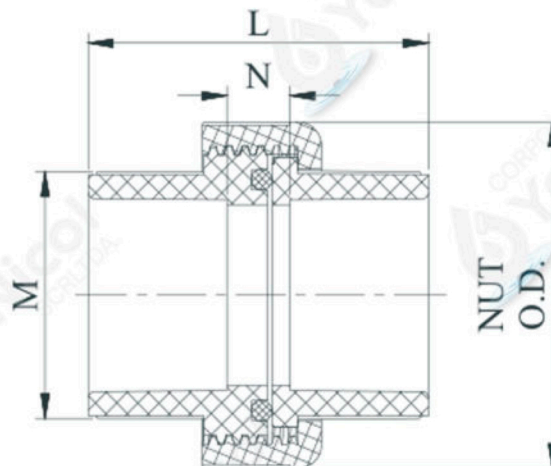



UNION UNIVERSAL MIXTA

Marca: LESSO

Material: PVC

Estandar: SCH-80

Conexion: NPT/MIXTA

Medidas: 1/2" > 2



JX Series

• TABLA DE DIMENSIONES

Size(in)	N	L	M	NUT O.D.	Weight (Lbs)
1/2	5/16	1-15/16	1-1/4	1-15/16	0.1391
3/4	13/32	2-13/32	1-15/32	2-3/16	0.1898
1	13/32	2-21/32	1-13/16	2-19/32	0.2899
1-1/4	15/32	2-3/4	2-3/16	3	0.4010
1-1/2	5/8	3-5/32	2-7/16	3-7/16	0.5564
2	25/32	3-15/32	2-31/32	4-1/16	0.8223

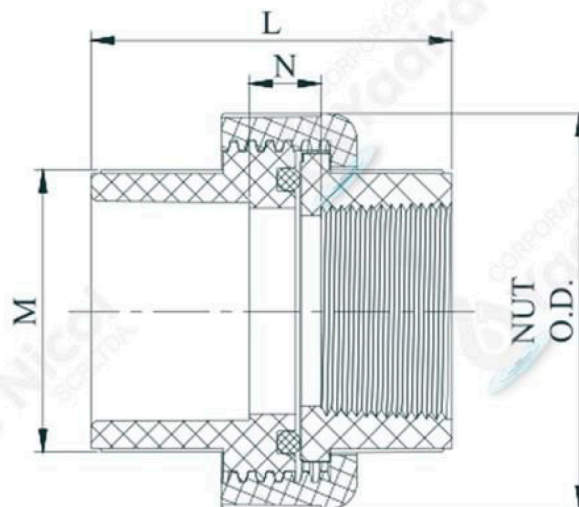



UNION UNIVERSAL CON ROSCA

Marca: LESSO

Material: PVC

Estandar: SCH-80

Conexion: NPT

Medidas: 3/8" > 4"



JX Series

• TABLA DE DIMENSIONES

Size(in)	N	L	M	NUT O.D.	Weight (Lbs)
3/8	9/32	1-17/32	7/8	1-9/16	0.0697
1/2	5/16	2-1/16	1-1/4	1-15/16	0.1358
3/4	13/32	2-13/32	1-15/32	2-3/16	0.1812
1	7/16	2-11/16	1-13/16	2-19/32	0.2703
1-1/4	15/32	2-31/32	2-3/16	3	0.3911
1-1/2	5/8	3-3/8	2-7/16	3-7/16	0.5461
2	11/16	3-11/16	2-31/32	4-1/16	0.7994
3	23/32	4-15/32	4-1/4	5-1/2	1.7342

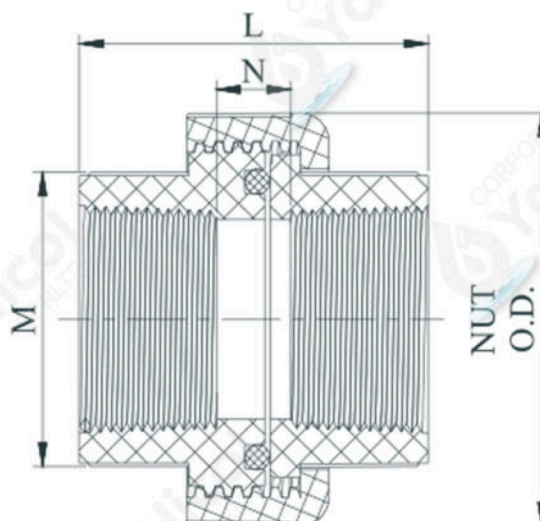



YEE

Marca: LESSO

Material: PVC

Estandar: SCH-80

Conexion: ANSI

Medidas: 1/2" > 6



JX Series

• TABLA DE DIMENSIONES

Size(in)	G	G1	G2	H	H1	H2	M	M1	Weight (Lbs)
2	21/32	3-5/32	3-5/32	2-5/32	4-21/32	4-21/32	2-29/32	2-29/32	1.0754
4	1-1/16	5-25/32	5-25/32	3-5/16	8-1/32	8-1/32	5-1/4	5-1/4	4.6723
6	1-9/32	8-15/32	8-15/32	4-9/32	11-15/32	11-15/32	7-19/32	7-19/32	13.2589

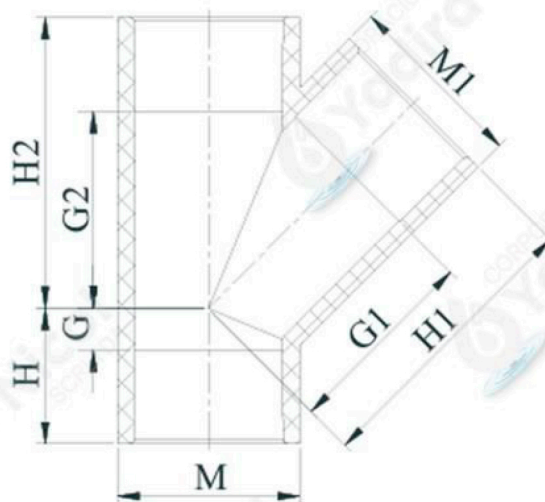



YEE CON REDUCCION

Marca: LESSO

Material: PVC

Estandar: SCH-80

Conexion: ANSI

Medidas: 3/4" x 3/4" x
1/2" >
6" x 6" x 4"



JX Series

• TABLA DE DIMENSIONES

Size (in)	Std PK	Mstr Ctn
3/4x3/4x1/2	20	120
1x1x3/4	20	80
1-1/2x1-1/2x3/4	20	80
1-1/2x1-1/2x1	20	80
1-1/2x1-1/2x1-1/4	15	60
2x2x1-1/2	10	40
2-1/2x2-1/2x2	4	24
3x3x2	10	0
3x3x2-1/2	8	0
4x4x2	5	0
4x4x3	5	0
6x6x2	5	0
6x6x3	5	0
6x6x4	3	0

